

Data Sheet



Article number: 604133040085

Description: Taper bored timing belt pulley
HTD 40 14M 85 TL 3020

Measures

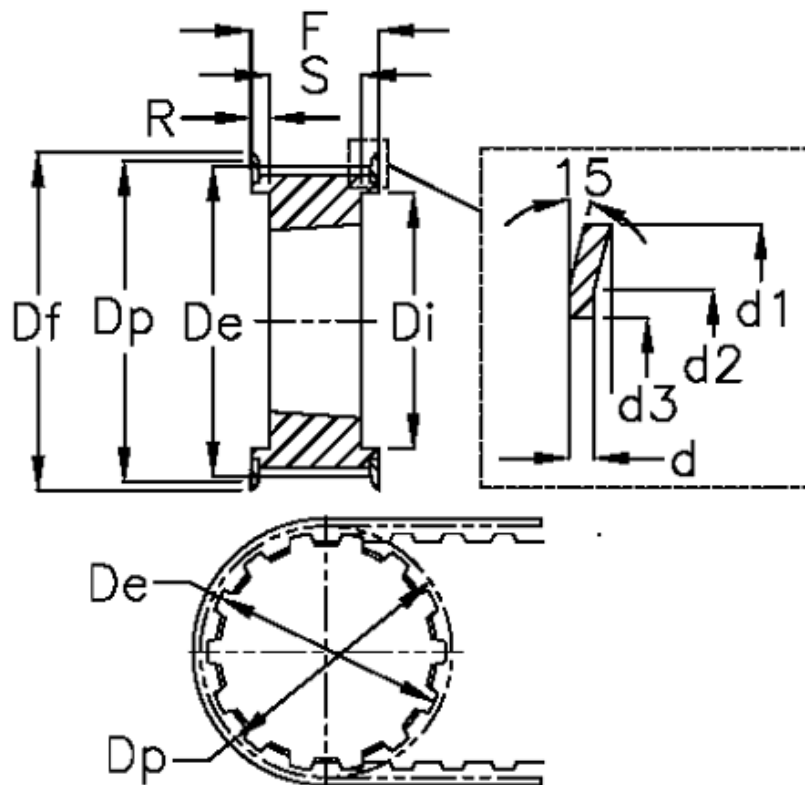

$d = 2.5$	F = 102	Weight = 8
$d1 = 188$	Flange type = F56	Width = 85
$d2 = 176$	For bushing = 3020	
$d3 = 150$	Max bore = 75	
$De = 175.49$	r = 25.5	
$Df = 188$	S = 51	
$Di = 138$	Tooth number = 40	
$Dp = 178.25$	Type = 14M	